

# eternoivica

I N N O V A T I O N L E A D E R

**SR**  
**SRT**

**Supporto regolabile autolivellante**

**Reversus®**

**Reversus® adjustable and self-leveling support**

IT | EN

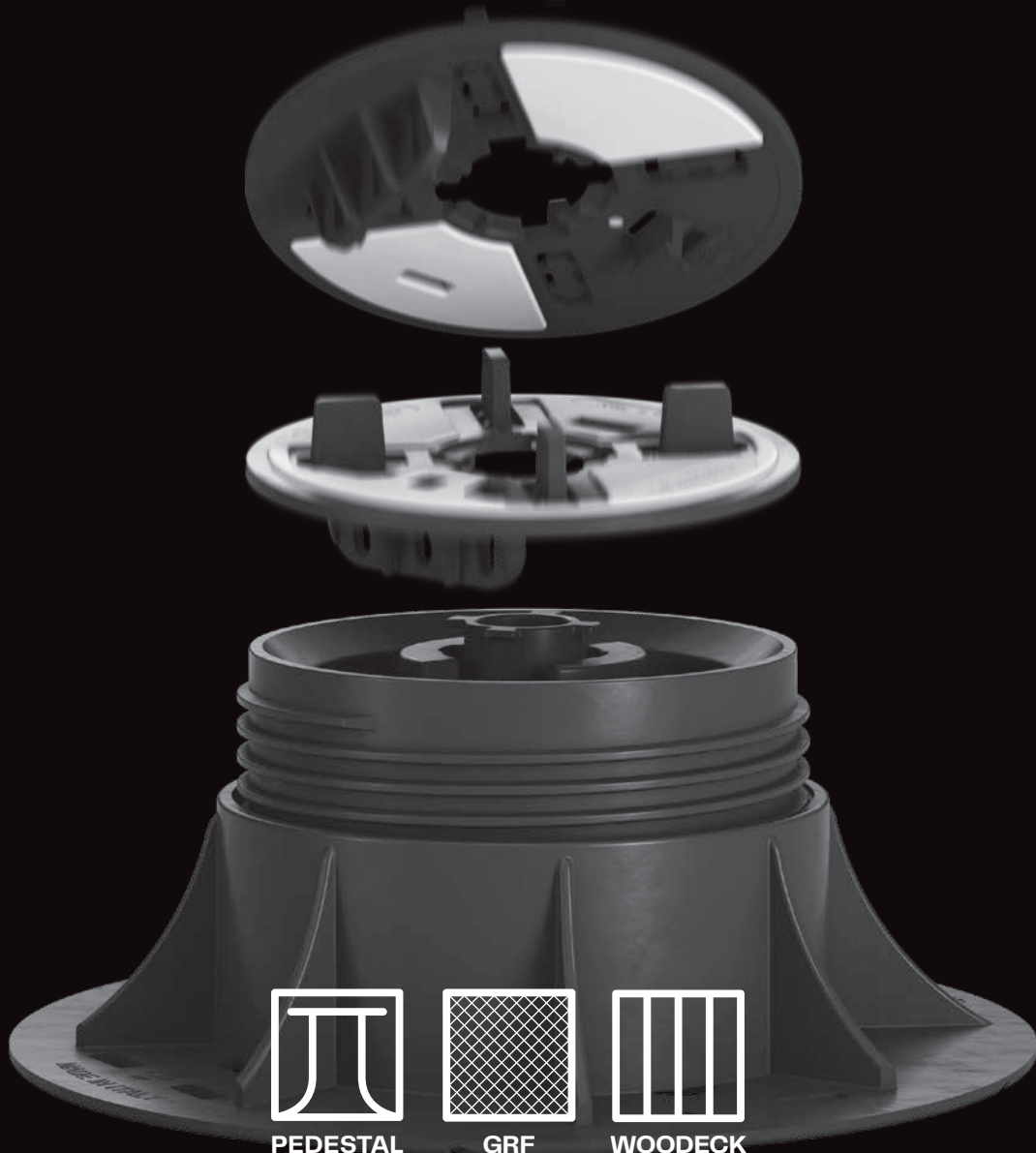

PEDESTAL

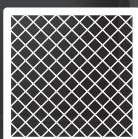

GRF



WOODECK

# SR/SRT

## Descrizione componenti Components description



Testa in bicomponente  
(PP+gomma) per lastre  
*Two-component head  
(PP+rubber) for slabs*



Testa in bicomponente  
(PP+gomma) per travetto  
*Two-component head  
(PP+rubber) for joist*

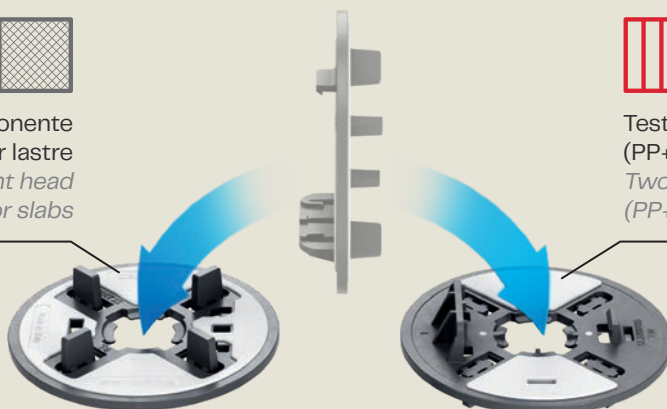

Accessorio per rendere basculante  
la testa (opzionale)  
*Accessory to make the head tilt  
(optional)*

Vite  
*Screw*



Aggancio testa-vite  
*Coupling head to screw  
attachment system*

Prolunga (opzionale)  
*Extension (optional)*



Sistema di blocco  
dei componenti  
*Block System*



Guarda il video  
di presentazione



Watch the  
presentation video

Base con rottura facilitata  
*Easy-break base*

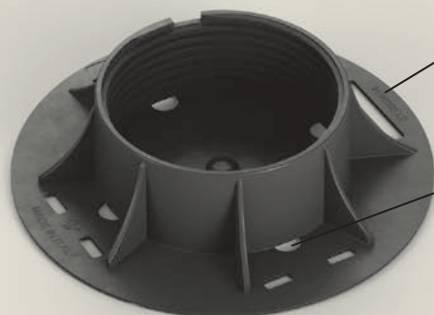

Fori scarico acqua  
*Water drainage holes*

# SR/SRT Supporto Reversus®

BREVETTATO

PATENTED

Reversus® support

## Il primo supporto al mondo con testa reversibile

The world's first support with a reversible head



Testa reversibile: un'unica testa per 3 soluzioni di posa  
*Reversible head: a single head for 3 laying solutions*



Base con rottura facilitata per una posa più rapida  
*Base with easy break for faster installation*

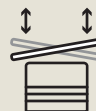

Testa fissa che si trasforma in autolivellante per compensare pendenze fino al 5%  
*Fixed head that transforms into a self-leveling head to compensate slopes up to 5%*

### Teste reversibili

### Reversible heads

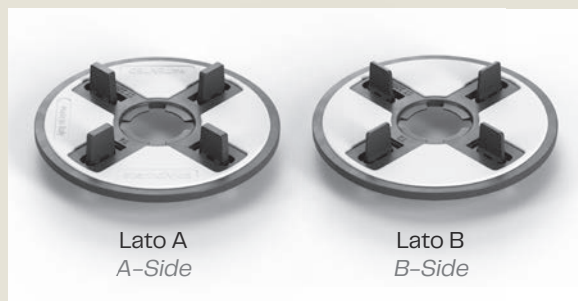

Lato A  
A-Side

Lato B  
B-Side

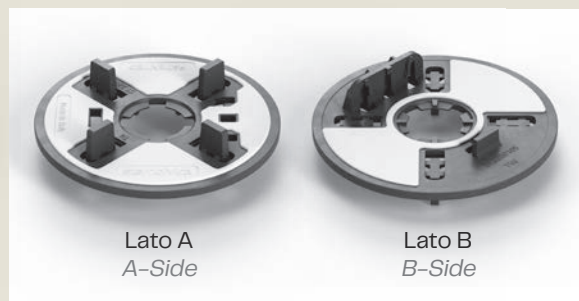

Lato A  
A-Side

Lato B  
B-Side

## SR

La testa reversibile SR è predisposta per la posa delle lastre mono e multi formato con alette di spessore 4 mm da un lato e 2 mm dall'altro.

Questa versione di testa è indicata per coloro che posano esclusivamente lastre mono e multiformato, in questo caso si potrà scegliere all'ultimo momento, anche in cantiere stesso, se utilizzare le alette da 4 mm o quelle da 2 mm.

*The reversible SR head is set up for laying single and multi-format slabs, with 4 mm thick tabs.*

*This version of the head is suitable for those who only lay single and multi-format slabs, in this case you can choose from all last moment, even on the construction site itself, whether to use the 4 mm tabs or the 2 mm ones.*

## SRT

Un lato della testa reversibile è predisposto per la posa del travetto di alluminio e legno. Il travetto di alluminio si inserisce a scatto con una semplice pressione delle mani mentre il travetto in legno si appoggia alla parete verticale e si fissa con le normali viti autofilettanti. All'occorrenza c'è la possibilità di utilizzare la testa a incrocio per travetto in alluminio. L'altro lato della testa è predisposto per la posa delle lastre con alette da 4 mm.

*One side of the reversible head is designed for the installation of the aluminum and wooden joist. The aluminum joist snaps into place with a simple pressure of the hands while the wooden joist leans against the vertical wall and is fixed with the normal self-threading screws. If necessary, there is the possibility of using the cross head for aluminum joists. The other side of the head is designed for laying slabs with 4 mm thick tabs.*

# Le teste: una soluzione 3 in 1

## The heads: a 3-in-1 solution

BREVETTATO

PATENTED

La grande novità di questo nuovo supporto è la testa reversibile in bi-componente (PP + gomma), da un lato ha le alette per la posa delle lastre e dall'altro lato è predisposta per la posa dei travetti in alluminio e legno. Inoltre, se non utilizzi mai il travetto puoi avere la testa reversibile con alette da 4 mm da un lato e alette da 2 mm dall'altro.

*The great novelty of this new support is the reversible head in two-component (PP + rubber), on one side it has the tabs for laying the slabs and on the other side it is designed for the laying of aluminum and wooden joists. Also, if you never use the joist you can have the reversible head with 4 mm tabs on one side and 2 mm tabs on the other.*



Testa in bimatereale (PP+gomma) per lastre  
*Two-component head (PP+rubber) for slabs*

Testa in bimatereale (PP+gomma) per travetto  
*Two-component head (PP+rubber) for joist*

### Misure supporti SR/SRT 1 - SR/SRT 5 supports size SR/SRT 1 - SR/SRT 5



**SR/SRT 1**  
26 - 38 mm



**SR/SRT 2**  
38 - 60 mm



**SR/SRT 3**  
59 - 100 mm



**SR/SRT 4**  
93 - 162 mm



**SR/SRT 5**  
158 - 280 mm

# SR



## Supporto con testa reversibile Reversus® per posa lastre direttamente sui supporti o su griglia

Reversus® support with reversible head for laying slabs directly  
on supports or on a grid



CODICE CODE	TIPO TYPE	MISURA SIZE	TESTA REVERSIBILE REVERSIBLE HEAD		PZ 	PZ 	
			Lato A   A-Side	Lato B   B-Side		Italy	Abroad
E030020304	SR 1	26-38 mm	Aletta 4 mm - H 12 mm <i>4 mm tab - H 12 mm</i>	Aletta 2 mm - H 12 mm <i>Tabs 2 mm H 12 mm</i>	20	1200	1320
E030020406	SR 2	38-60 mm	Aletta 4 mm - H 12 mm <i>4 mm tab - H 12 mm</i>	Aletta 2 mm - H 12 mm <i>Tabs 2 mm H 12 mm</i>	20	840	960
E030020610	SR 3	59-100 mm	Aletta 4 mm - H 12 mm <i>4 mm tab - H 12 mm</i>	Aletta 2 mm - H 12 mm <i>Tabs 2 mm H 12 mm</i>	20	600	720
E030020916	SR 4	93-162 mm	Aletta 4 mm - H 12 mm <i>4 mm tab - H 12 mm</i>	Aletta 2 mm - H 12 mm <i>Tabs 2 mm H 12 mm</i>	20	480	480
E030021628	SR 5	158-280 mm	Aletta 4 mm - H 12 mm <i>4 mm tab - H 12 mm</i>	Aletta 2 mm - H 12 mm <i>Tabs 2 mm H 12 mm</i>	20	360	420

Il codice si riferisce al supporto completo di testa SR  
aletta 4 mm H 12 mm/aletta 2 mm H 12 mm Ø 110 mm.

The code refers to the support with SR head tabs 4 mm  
H 12 mm/tabs 2 mm H 12 mm Ø 110 mm.

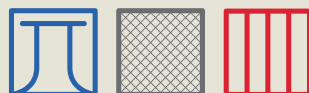

# SRT



Supporto con testa reversibile Reversus®  
per posa con travetto in alluminio o legno  
e per posa lastre direttamente sui supporti  
o su griglia

Reversus® support with reversible head for laying with aluminum/wooden joist  
and for laying slabs directly on supports or on a grid



CODICE CODE	TIPO TYPE	MISURA SIZE	TESTA REVERSIBILE REVERSIBLE HEAD		PZ 	PZ 	
			Lato A   A-Side	Lato B   B-Side		Italy	Abroad
E030010304	SRT 1	26-38 mm	Aletta 4 mm - H 12 mm 4 mm tab - H 12 mm	Travetto alluminio/legno Aluminium / wood joist	20	1200	1320
E030010406	SRT 2	38-60 mm	Aletta 4 mm - H 12 mm 4 mm tab - H 12 mm	Travetto alluminio/legno Aluminium / wood joist	20	840	960
E030010610	SRT 3	59-100 mm	Aletta 4 mm - H 12 mm 4 mm tab - H 12 mm	Travetto alluminio/legno Aluminium / wood joist	20	600	720
E030010916	SRT 4	93-162 mm	Aletta 4 mm - H 12 mm 4 mm tab - H 12 mm	Travetto alluminio/legno Aluminium / wood joist	20	480	480
E030011628	SRT 5	158-280 mm	Aletta 4 mm - H 12 mm 4 mm tab - H 12 mm	Travetto alluminio/legno Aluminium / wood joist	20	360	420

Il codice si riferisce al supporto completo di testa SRT  
lastre aletta 4 mm H 12 mm/travetto Ø 110 mm.



The code refers to the support with slab tab 4 mm  
H 12 mm/joist SRT head Ø 110 mm.

# Supporto Reversus® (Base + Vite)

Reversus® support (Base + Screw)

**TESTA ESCLUSA**

**HEAD EXCLUDED**

CODICE BASE + VITE CODE BASE + SCREW	DESCRIZIONE DECIPTION	MISURA SIZE	PZ 	PZ 	
				Italy	Abroad
E030030304	SRT - SR 1 base + vite <i>SRT - SR 1 base + screw</i>	26-38 mm*	20	1200	1320
E030030406	SRT - SR 2 base + vite <i>SRT - SR 2 base + screw</i>	38-60 mm*	20	840	960
E030030610	SRT - SR 3 base + vite <i>SRT - SR 3 base + screw</i>	59-100 mm*	20	600	720
E030030916	SRT - SR 4 base + vite <i>SRT - SR 4 base + screw</i>	93-162 mm*	20	480	480
E030031628	SRT - SR 5 base + vite <i>SRT - SR 5 base + screw</i>	158-280 mm*	20	360	420
E030001010	Testa reversibile alette 4 mm / Travetto in alluminio e legno <i>Reversible head with 4 mm tabs / aluminium and wooden joist</i>	Ø 110 mm	200	6400	
E030001020	Testa reversibile alette 4/2 mm H 12 mm <i>Reversible head tabs 4/2 mm H 12 mm</i>	Ø 110 mm	200	6400	
E030001030	Testa reversibile alette 4 mm / Travetto in alluminio e legno <i>Reversible head with 4 mm tabs / aluminium and wooden joist</i>	Ø 150 mm	100	3200	
E030001040	Testa reversibile alette 4/2 mm H 12 mm <i>Reversible head tabs 4/2 mm H 12 mm</i>	Ø 150 mm	100	3200	



I codici dei supporti comprendono base e vite, senza testa.

\* Le misure indicate si riferiscono a Base + Vite + Testa Ø 110 mm autolivellante bicomponente.

The codes for the supports include the base and the screw, without the head.

\* The measurements indicated refer to Base + Screw + Self-leveling two-component head Ø 110 mm.

## Elementi aggiuntivi Addictional elements

CODICE CODE	DESCRIZIONE DECIPTION	MISURA SIZE	PZ 	PZ 
E044000145	Prolunga PNM <i>PNM Extension</i>	-	30	600
E030001000	Accessorio per rendere basculante la testa al 5%* <i>Accessory to make the head tilting up to 5%*</i>	Ø 110 - 150 mm	200	6400
Q193000203	Viti a croce per fissaggio travetto in legno <i>Cross screws for fixing wooden joist</i>	Ø 3,5 mm L 20 mm	1000	-

\* Aumenta l'altezza del supporto di 5 mm.

\* It increases the height of the support by 5 mm.



MADE IN ITALY

eternoivica

**ETERNO IVICA SRL**

via Austria 25 / E  
Z.I. Sud - 35127 Padova - Italy

ITA +39 049 8530101  
EXP +39 049 8530102  
FAX +39 049 8530111

eternoivica@eternoivica.com  
www.eternoivica.com