



UNIVERSA
UNIVERSIS
PATAVINA
LIBERTAS

UNIVERSITÀ DEGLI STUDI DI PADOVA

DIPARTIMENTO DI INGEGNERIA CIVILE, EDILE E AMBIENTALE
Laboratorio Sperimentale per le Prove sui Materiali da Costruzione
DEPARTMENT OF CIVIL, ENVIRONMENTAL AND ARCHITECTURAL ENGINEERING
Building materials testing Laboratory

Sede: via Marzolo n. 11/A - 35131 PADOVA
Segreteria: +39.049.827.5607

Fax: +39.049.827.5587
e-mail: lab.materiali@dicea.unipd.it

TEST REPORT N. 35383

Page 1/2

Applicant: Eterno Ivica S.r.l., via Austria Z.I. n. 25/E - Padova

Application: Received at 22/01/2013

Material: 3 samples of pedestal "SUPPORT BASIC SB1" series, received at 22/01/2013

Required test: Measure the maximum compressive eccentric load of the specimen and the displacement of the testing machine's crossbar.

Testing method: The compression tests were made for all the 3 samples. The components of the pedestal had been assembled, the height of pedestal was regulated to the medium stroke of the screw (31.0 mm).
Testing speed set to 10 mm/min (checking movement of moving crossbar of the universal testing machine Galdabini, type Sun/60, with a load capacity of 600 kN).
The load applied with hardened steel plate on the base of specimen and a steel rectangular prism on the top of the pedestal with an eccentricity of 27.5 mm.
The values of maximum load (F_{max}) are the values of load at first failure/rupture.
The testing machine's certificate of calibration is n°020-13F about Calibration centre LAT n° 34 with due data January 15th, 2014.
Test activities were carried out on April 3rd, 2013.
For any technical and dimensional detail, assembling scheme and any other information not included in this document, brochures and technical data sheets are at Applicant's disposal.

Test Result

Specimen	Max Load F_{max} [kN]	Stroke at F_{max} [mm]
1	7.51	3.5
2	9.18	3.9
3	8.39	3.7

Padova, May 2nd, 2013

Laboratory Chief
(Prof. **Claudio Modena**)

Department Chief
(Prof. **Carmelo Majorana**)



UNIVERSA
UNIVERSIS
PATAVINA
LIBERTAS

UNIVERSITÀ DEGLI STUDI DI PADOVA

DIPARTIMENTO DI INGEGNERIA CIVILE, EDILE E AMBIENTALE
Laboratorio Sperimentale per le Prove sui Materiali da Costruzione
DEPARTMENT OF CIVIL, ENVIRONMENTAL AND ARCHITECTURAL ENGINEERING
Building materials testing Laboratory

Sede: via Marzolo n. 11/A - 35131 PADOVA
Segreteria: +39.049.827.5607

Fax: +39.049.827.5587
e-mail: lab.materiali@dicea.unipd.it

TEST REPORT N. 35383

Page 2/2

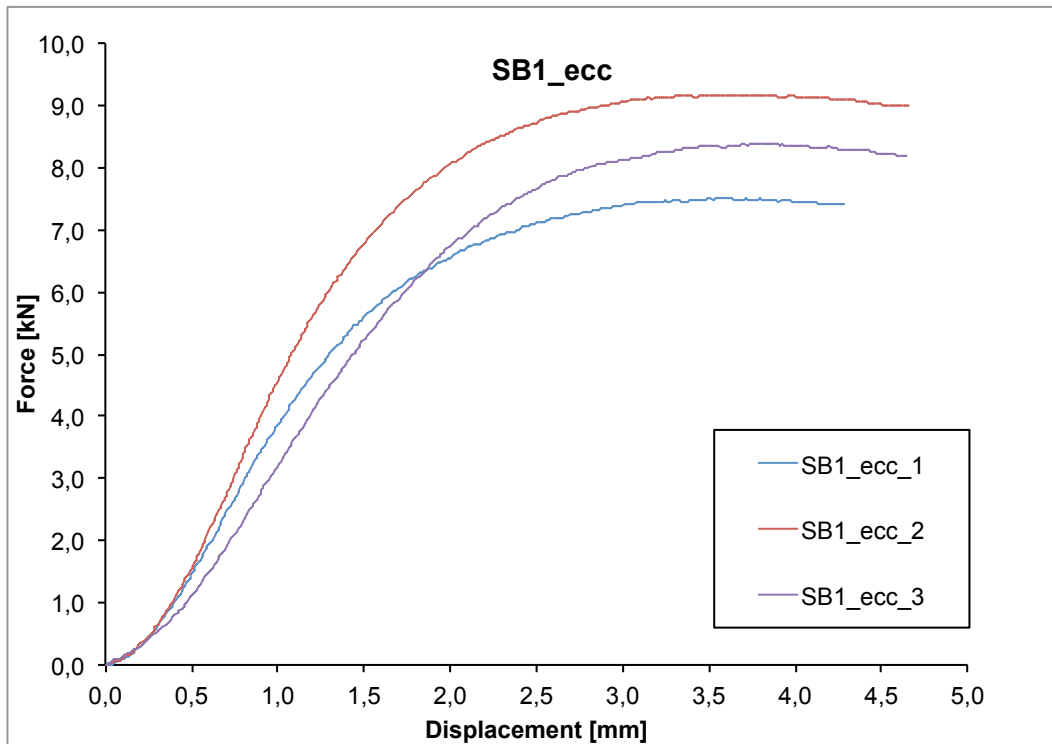

Figure 1 Diagram force versus displacement of testing machine's crossbar for "SUPPORT BASIC SB1" specimen.

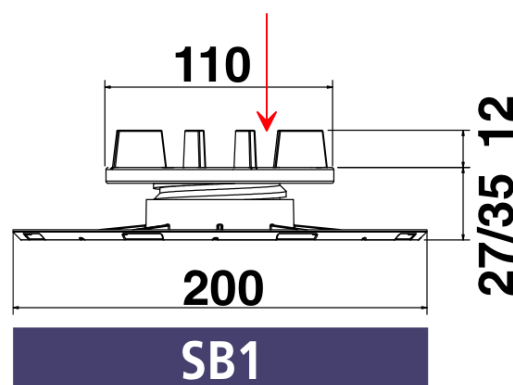

Figure 2 typical "SUPPORT BASIC SB1" specimen.

Padova, May 2nd, 2013

Laboratory Chief
(Prof. **Claudio Modena**)

Department Chief
(Prof. **Carmelo Majorana**)