

eternoivica

I N N O V A T I O N L E A D E R

Clip per tamponamento verticale

Vertical lining clip

IT | EN



WODECK

Clip tamponamento verticale per posa lastre in ceramica monoformato, multiformato e listoni in ceramica

Vertical lining clip for laying single, multi-size ceramic slabs and planks



Clip per tamponamento verticale testa
Upper clip for vertical closure



Clip per tamponamento verticale base
Lower clip for vertical closure

Questa soluzione è composta da due particolari clip in acciaio inox, conformate in modo da accoppiarsi perfettamente con il travetto in alluminio e sotto la base del supporto Eterno Ivica.

In questo modo si crea l'aggancio a cui si fisserà il tamponamento verticale opportunamente dimensionato.

È disponibile per lastre con spessore 20, 30 e 40 mm.

This solution consists of two particular stainless steel clips, properly shaped as to perfectly fit with the aluminium joist and under the base of the Eterno Ivica support.

This creates the coupling to which the suitably sized infill board will be fixed.

It is available for 20, 30 and 40 mm thick slabs.

CODICE CODE	DESCRIZIONE DESCRIPTION	COMPATIBILITÀ SUPPORTI COMPATIBILITY SUPPORTS	Ø TESTA SUPPORTI Ø HEAD SUPPORTS	SPESSORE LASTRA* SLAB THICK- NESS*	PZ 
P021000722	Clip testa <i>Head clip</i>	SE - NM - SB	110 mm	20 mm	100
		SRT	110/150 mm		
P021000822	Clip testa <i>Head clip</i>	PR - NM con base a rottura facilitata <i>PR - NM with easy break base</i>	110 mm	20 mm	100
			130 mm Criss Cross		
		SRT	157 mm Criss Cross		
P021000322	Clip base <i>Base Clip</i>	PR - SE - NM - SB	110 mm	20 mm	100
		PR - NM	130 mm Criss Cross		
		SRT	150 mm		
			157 mm Criss Cross		
P021000352	Clip base <i>Base Clip</i>	SE	130 mm Criss Cross	20 mm	100

* Disponibili anche per lastre spessore 30-40 mm

** Also available for 30-40 mm thick slabs*

Clip tamponamento angolare per posa lastre in ceramica mono- formato, multiformato e listoni in ceramica

Angular lining clip for laying single, multi-size ceramic slabs and planks

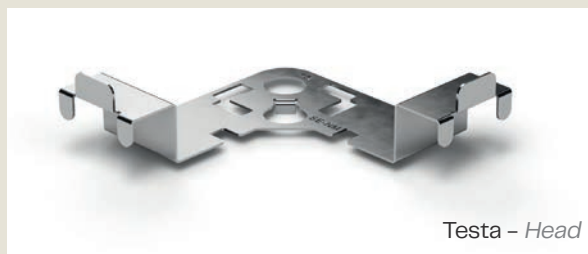

Testa - Head



Base - Base

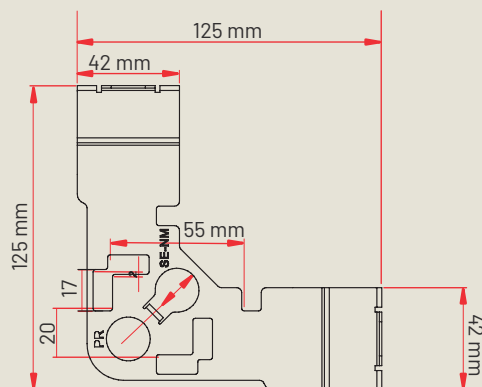
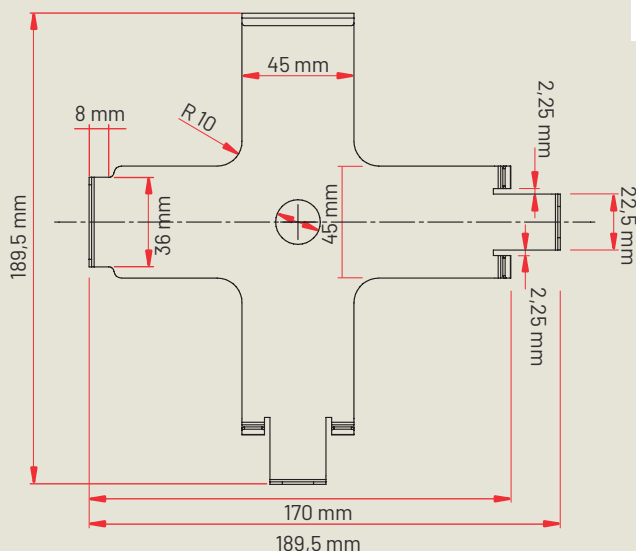

Questa particolare CLIP, sia di Testa che di Base, viene impiegata nel caso di un tamponamento verticale ad "angolo", anziché utilizzare due clip di Testa e due clip di Base si utilizza una unica clip di Testa e una unica clip di Base. È realizzata in acciaio inox, semplice e veloce da installare.

This particular CLIP, both Head and Base, is used in the case of a vertical "corner" infill, instead of using two Head clips and two Base clips, a single Head clip and a single Base clip are used. It is made of stainless steel, simple and quick to install.

CODICE CODE	DESCRIZIONE DESCRIPTION	COMPATIBILITÀ SUPPORTI COMPATIBILITY SUPPORTS	Ø TESTA SUPPORTI Ø HEAD SUPPORTS	SPESSORE LASTRA* SLAB THICKNESS*	PZ 
P021000952.N	Clip testa <i>Head clip</i>	PR - SE - NM - SB	110 mm	20 mm	25
		SRT	110/150 mm		
		PR - SE - NM	130 mm Criss Cross		
		SRT	157 mm Criss Cross		
P021000912	Clip base <i>Base Clip</i>	PR - SRT - SE - NM - SB	110 mm	20 mm	25
		PR - NM	130 mm Criss Cross		
		SRT	150 mm 157 mm Criss Cross		
P021000922	Clip base <i>Base Clip</i>	SE	130 mm Criss Cross	20 mm	25

* Disponibili anche per lastre spessore 30-40 mm

** Also available for 30-40 mm thick slabs*

Clip tamponamento verticale per posa listoni in legno/WPC (decking)

Vertical lining clip for laying wooden/WPC planks (decking)

1 Pavimentazione in legno, WPC o altro materiale
Wooden or other material floors

2 Travetto in alluminio
Aluminium joist

3 Clip di testa per tamponamento
verticale
Head clip for vertical infill

4 Supporto regolabile
Adjustable support

5 Clip base per tamponamento
verticale
Base clip for vertical infill

6 Clip per travetto in alluminio
Clip for aluminium joist



CODICE CODE	DESCRIZIONE DESCRIPTION	COMPATIBILITÀ SUPPORTI COMPATIBILITY SUPPORTS	Ø TESTA SUPPORTI Ø HEAD SUPPORTS	PZ 
P021000430	Clip testa <i>Head Clip</i>	SE - NM - SB	110 mm	100
P021000430.N	Clip testa <i>Head Clip</i>	SRT	110/150 mm	100
P021000432	Clip testa <i>Head Clip</i>	PR - NM con base a rottura facilitata <i>PR - NM with easy break base</i>	110 mm	100
P021000322	Clip base <i>Base clip</i>	PR - SE - NM - SB	110 mm	100
		SRT	110/150 mm	

Clip tamponamento verticale angolare per posa listoni in legno/WPC (decking)

Vertical angular lining clip for laying wooden/WPC planks (decking)

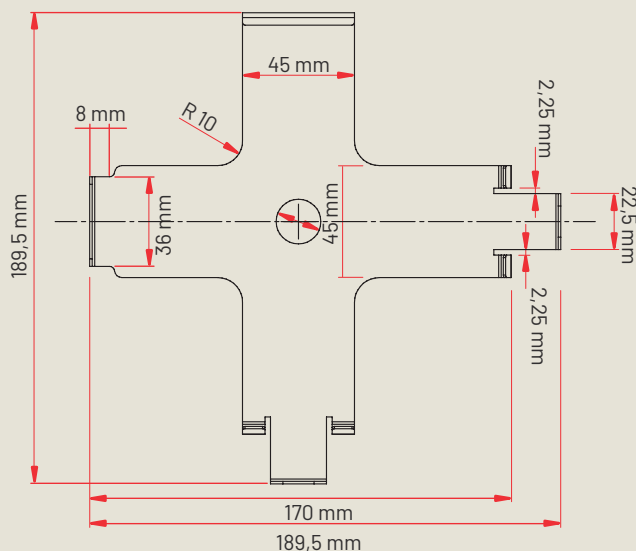
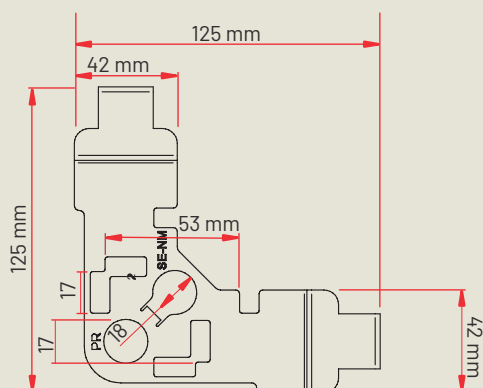

Questa particolare CLIP, sia di Testa che di Base, viene impiegata nel caso di un tamponamento verticale ad "angolo", anziché utilizzare due clip di Testa e due clip di Base si utilizza una unica clip di Testa e una unica clip di Base. È realizzata in acciaio inox, semplice e veloce da installare.

This particular CLIP, both Head and Base, is used in the case of a vertical "corner" infill, instead of using two Head clips and two Base clips, a single Head clip and a single Base clip are used. It is made of stainless steel, simple and quick to install.

CODICE CODE	DESCRIZIONE DESCRIPTION	COMPATIBILITÀ SUPPORTI COMPATIBILITY SUPPORTS	Ø TESTA SUPPORTI Ø HEAD SUPPORTS	PZ 
P021000932	Clip testa <i>Head clip</i>	PR - SE - NM - SB	110 mm	25
		SRT	110/150 mm	
P021000912	Clip base <i>Base clip</i>	PR - SE - NM - SB	110 mm	25
		SRT	110/150 mm	



HEADQUARTER



ETERNO IVICA SRL

via Austria 25 / E
Z.I. Sud - 35127 Padova - Italy

ITA +39 049 8530101
EXP +39 049 8530102
FAX +39 049 8530111

eternoivica@eternoivica.com
www.eternoivica.com

FILIALI BRANCHES



 eternoivica **uk**

Londra | *London*

 eternoivica **france**

Lione | *Lyon*

 eternoivica **eastern europe**

Zagabria | *Zagreb*

MADE IN ITALY

